

S
I
T
E

S
U
R
V
E
Y

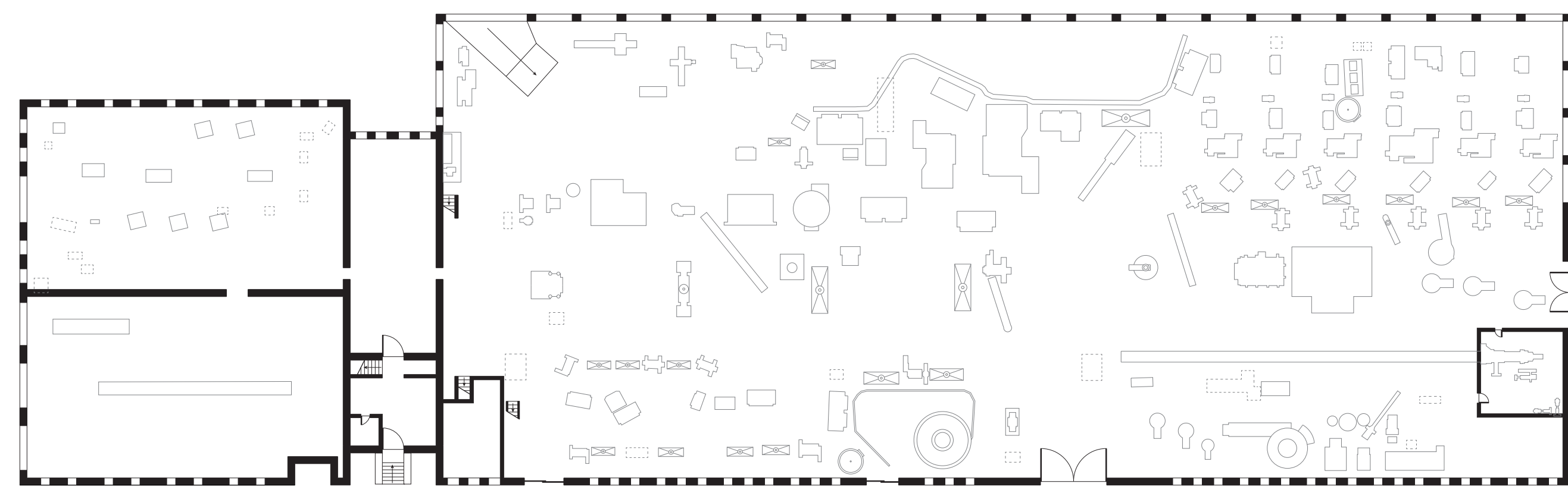

FIRST FLOOR

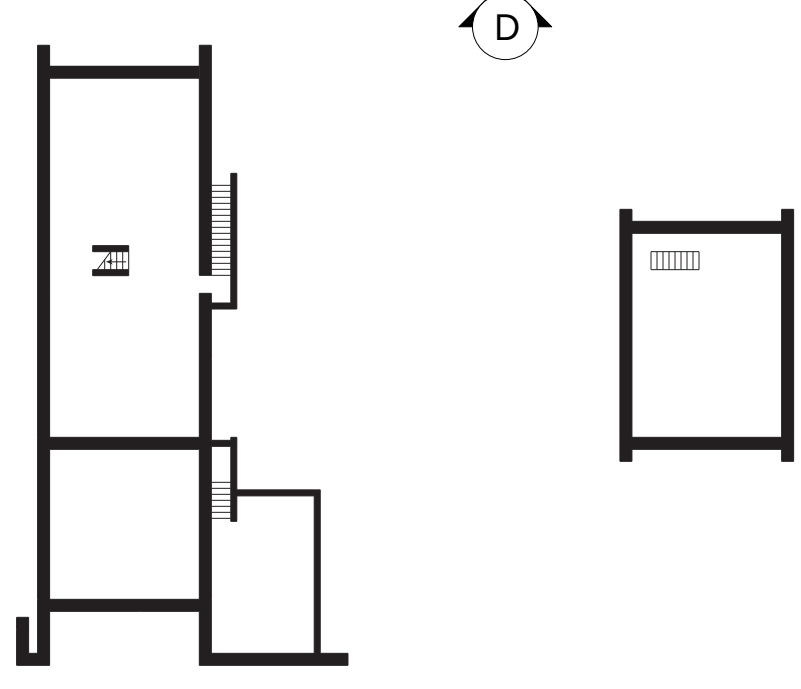

SECOND FLOOR

THIRD FLOOR

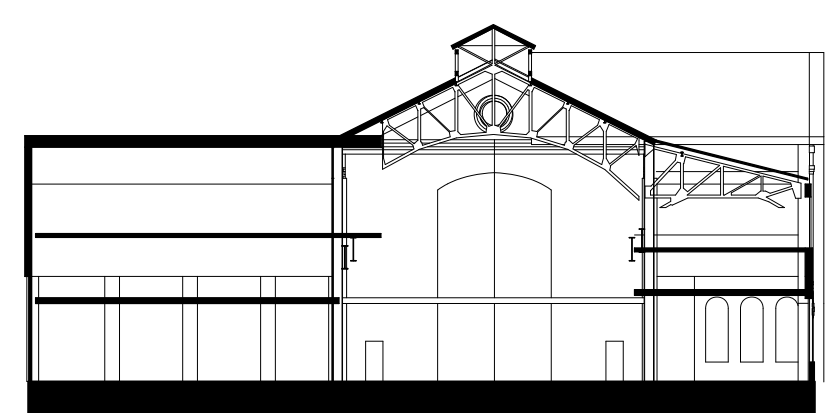

SECTION A

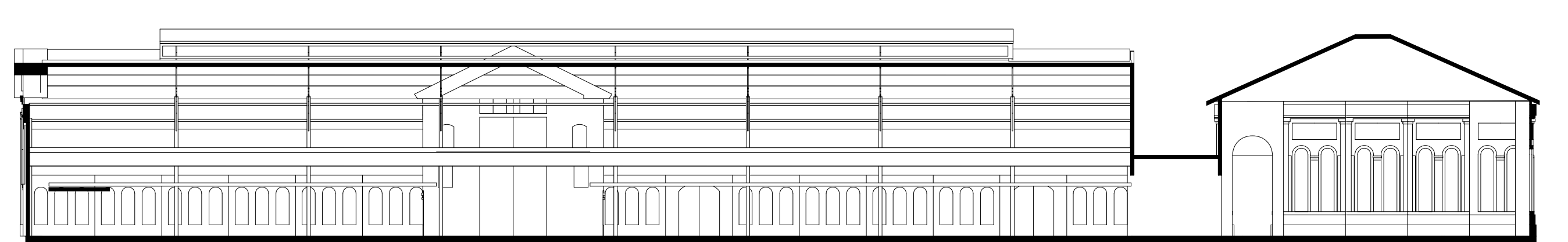

SECTION B

“GARDENS”

“ROOMS”

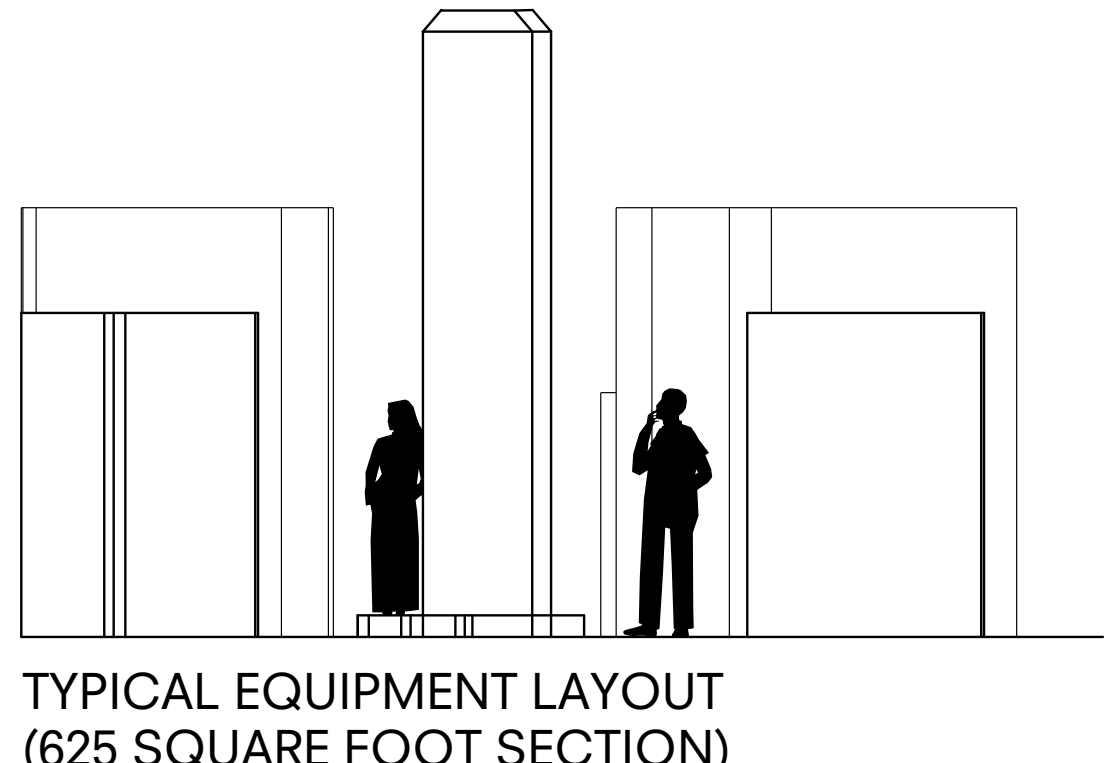
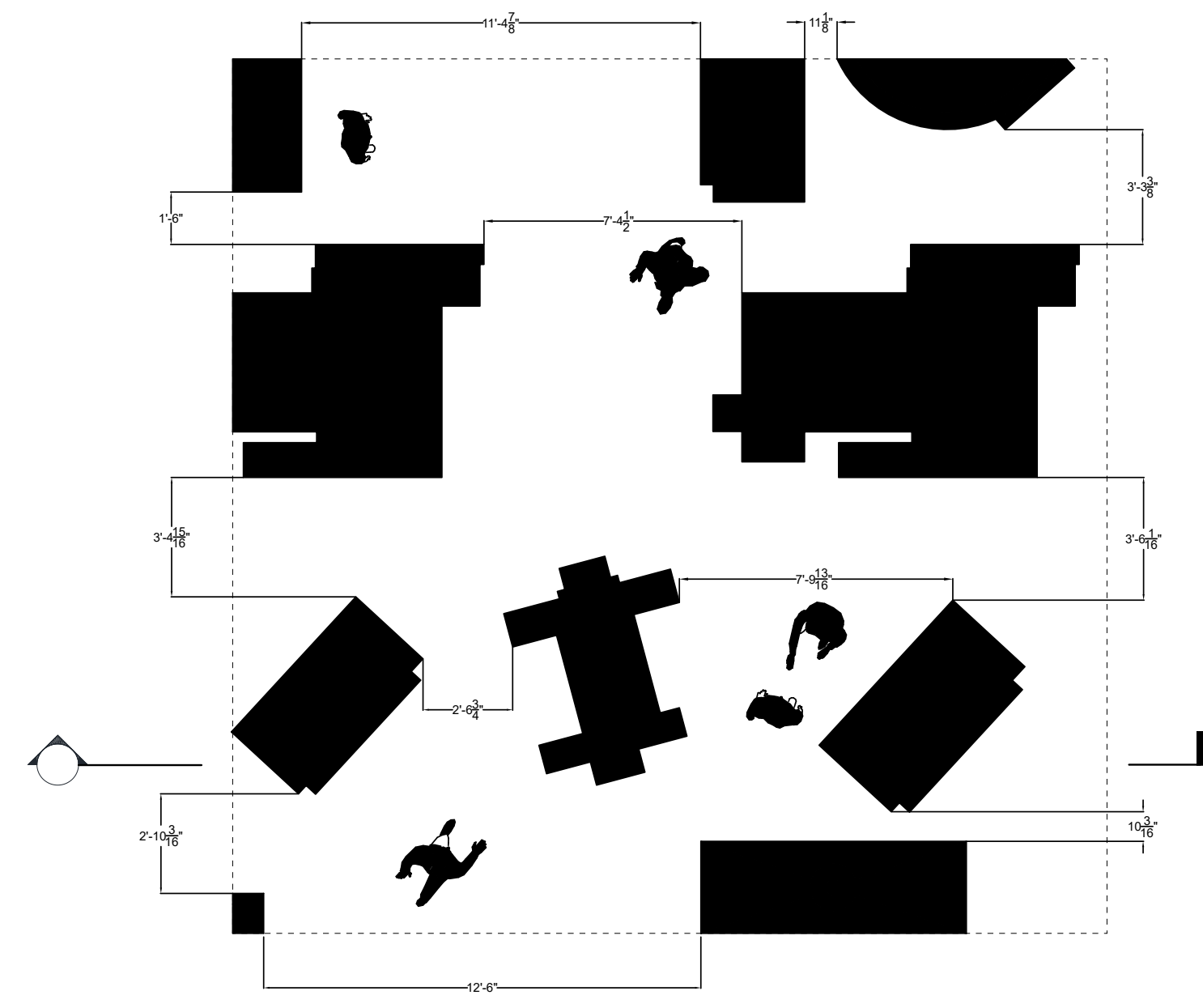
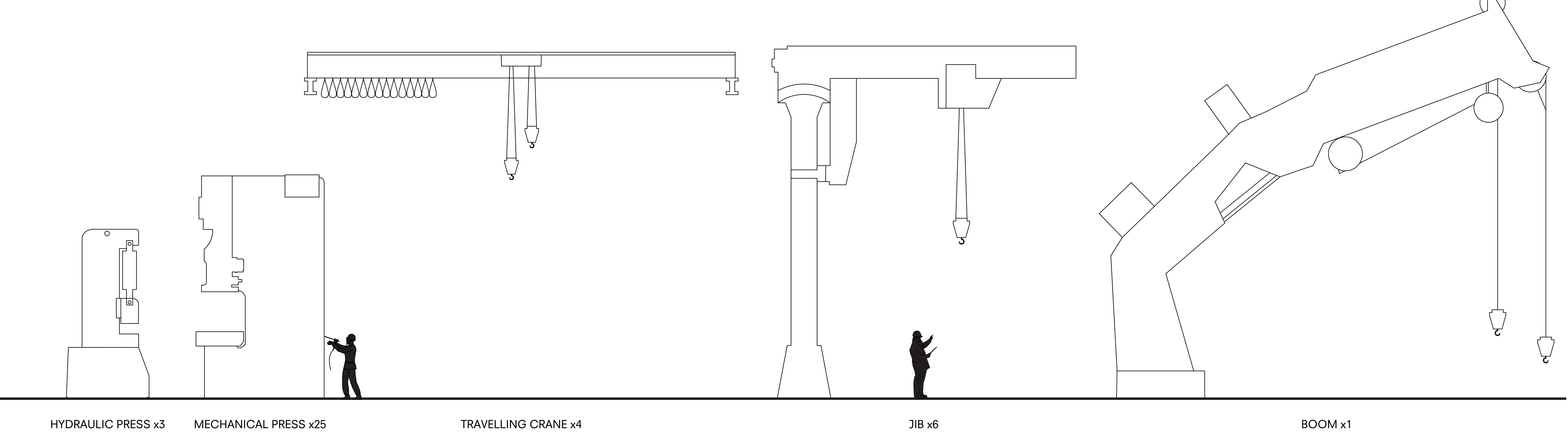
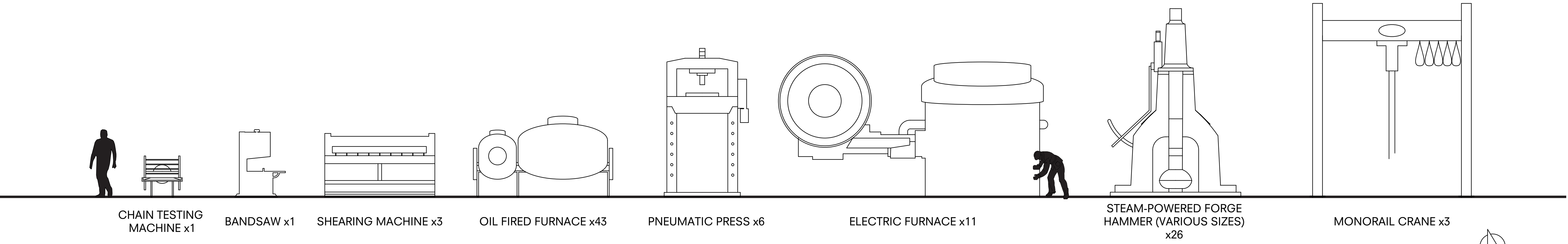
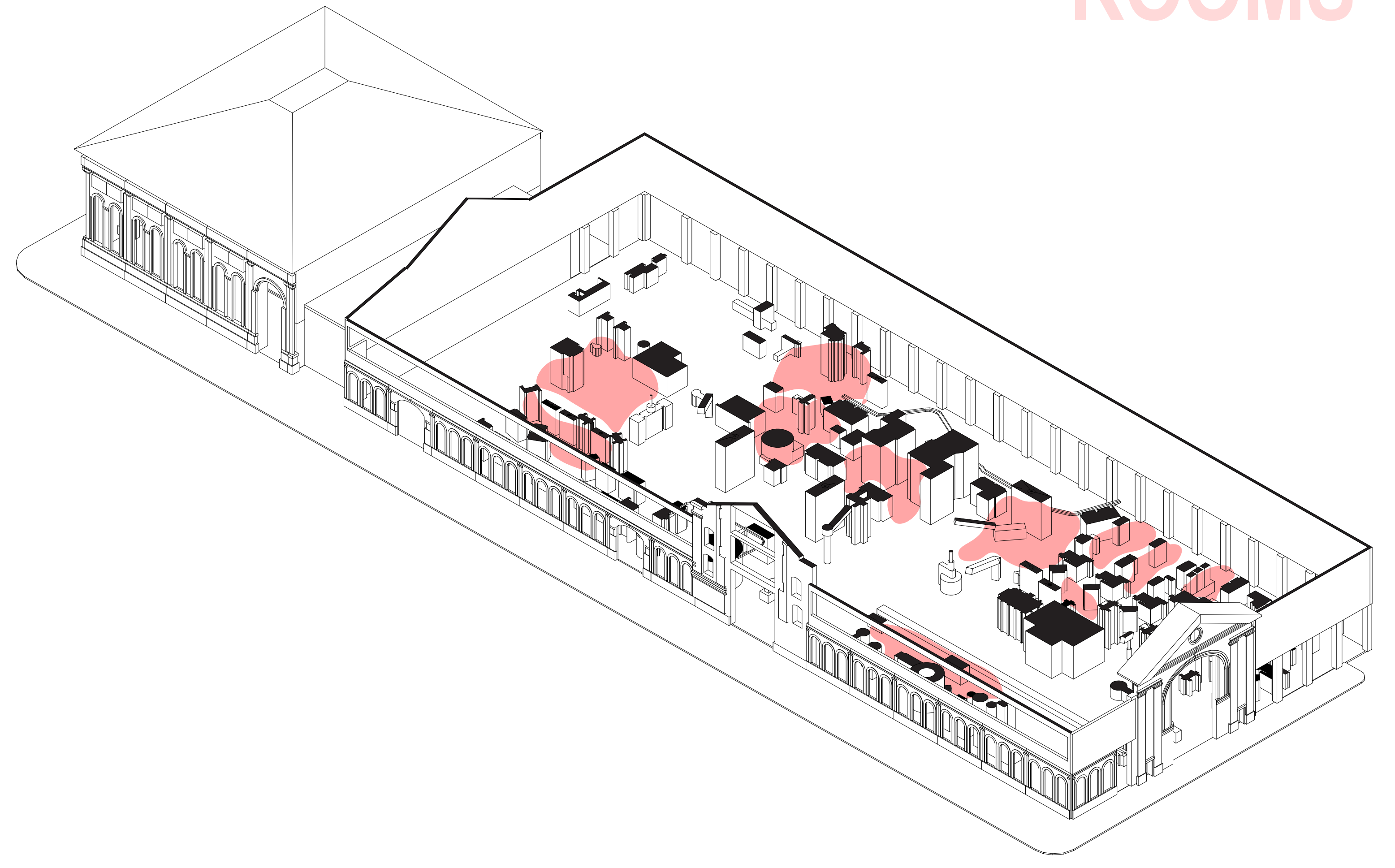
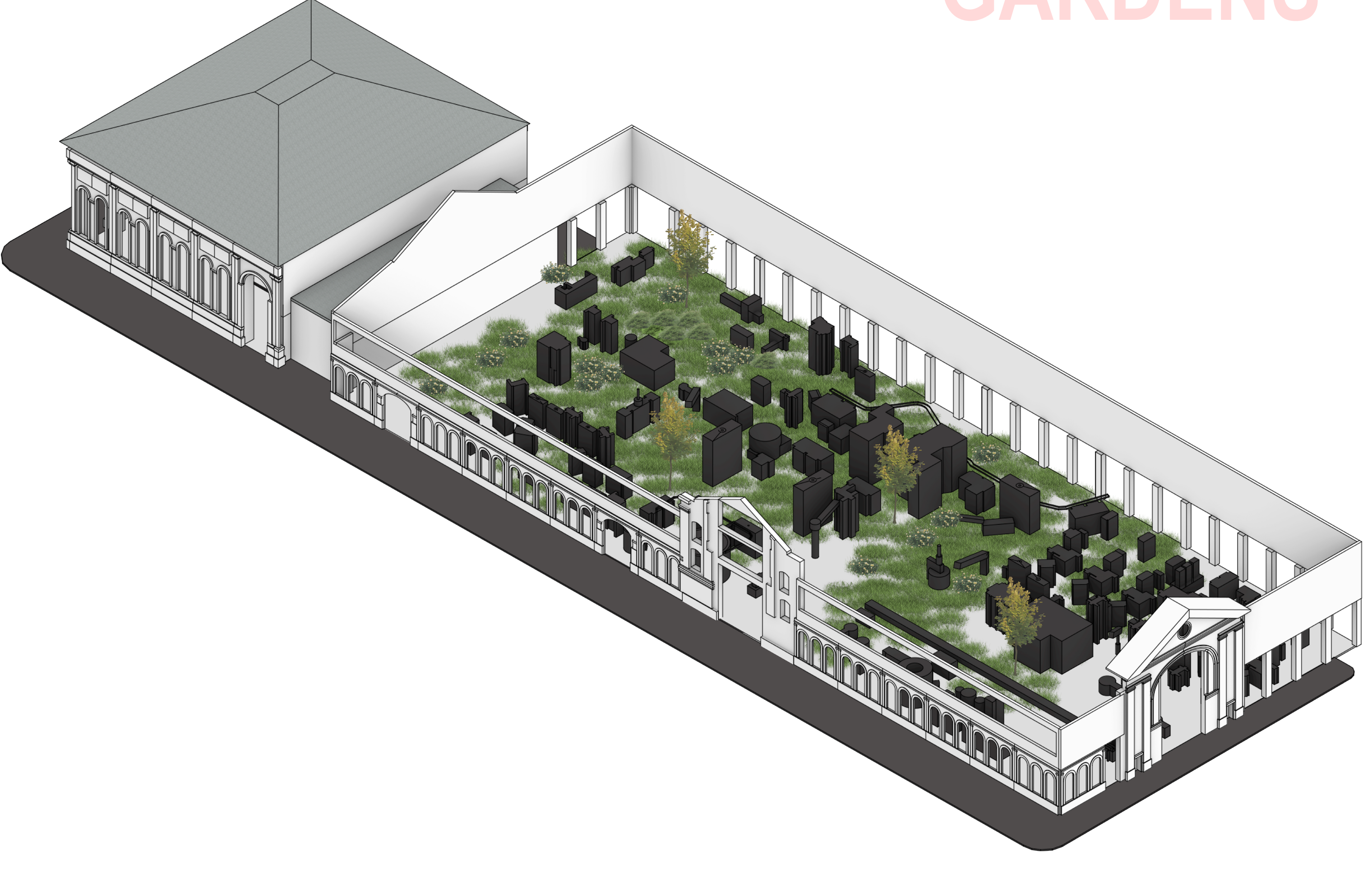

TYPICAL EQUIPMENT LAYOUT (625 SQUARE FOOT SECTION)

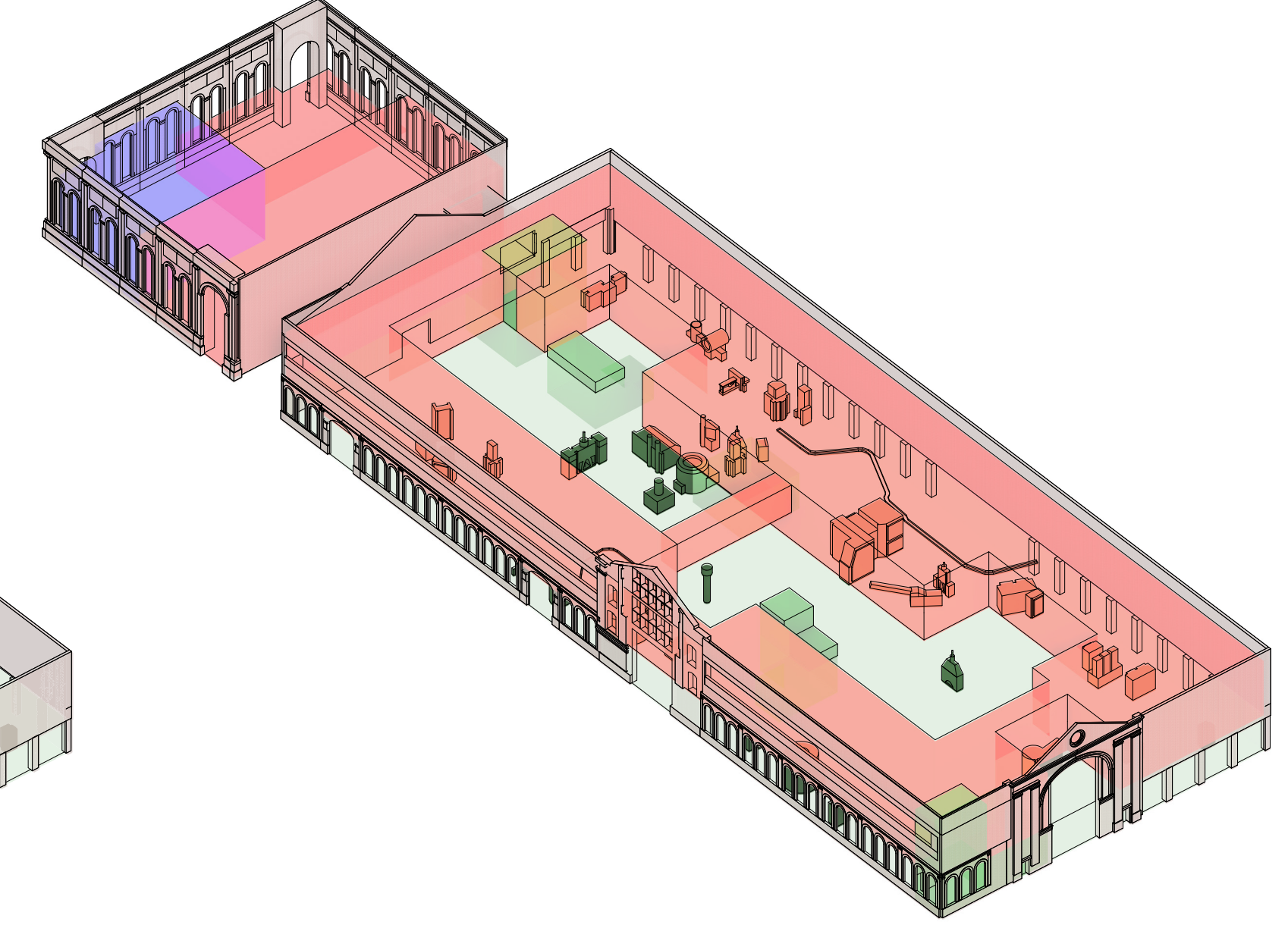
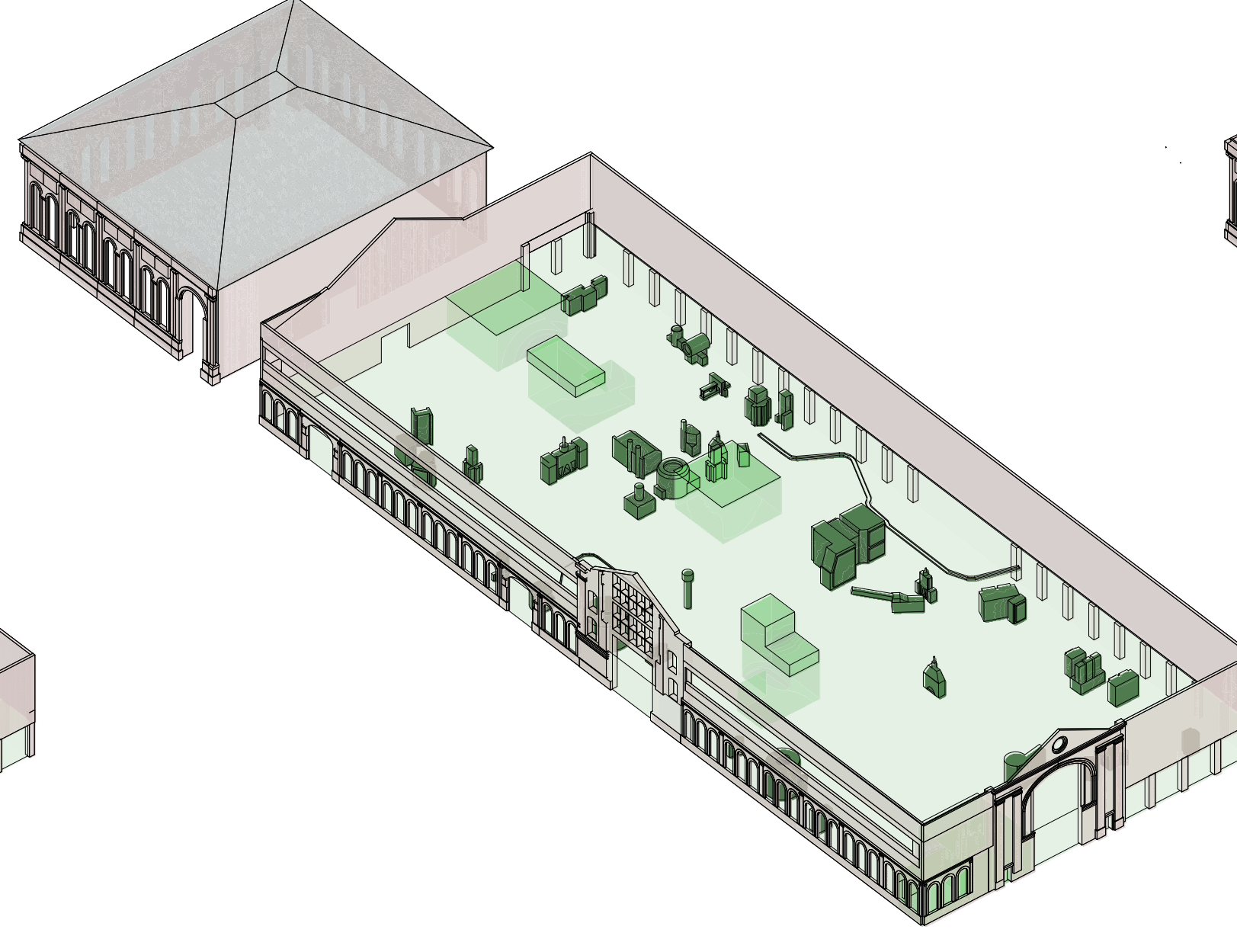
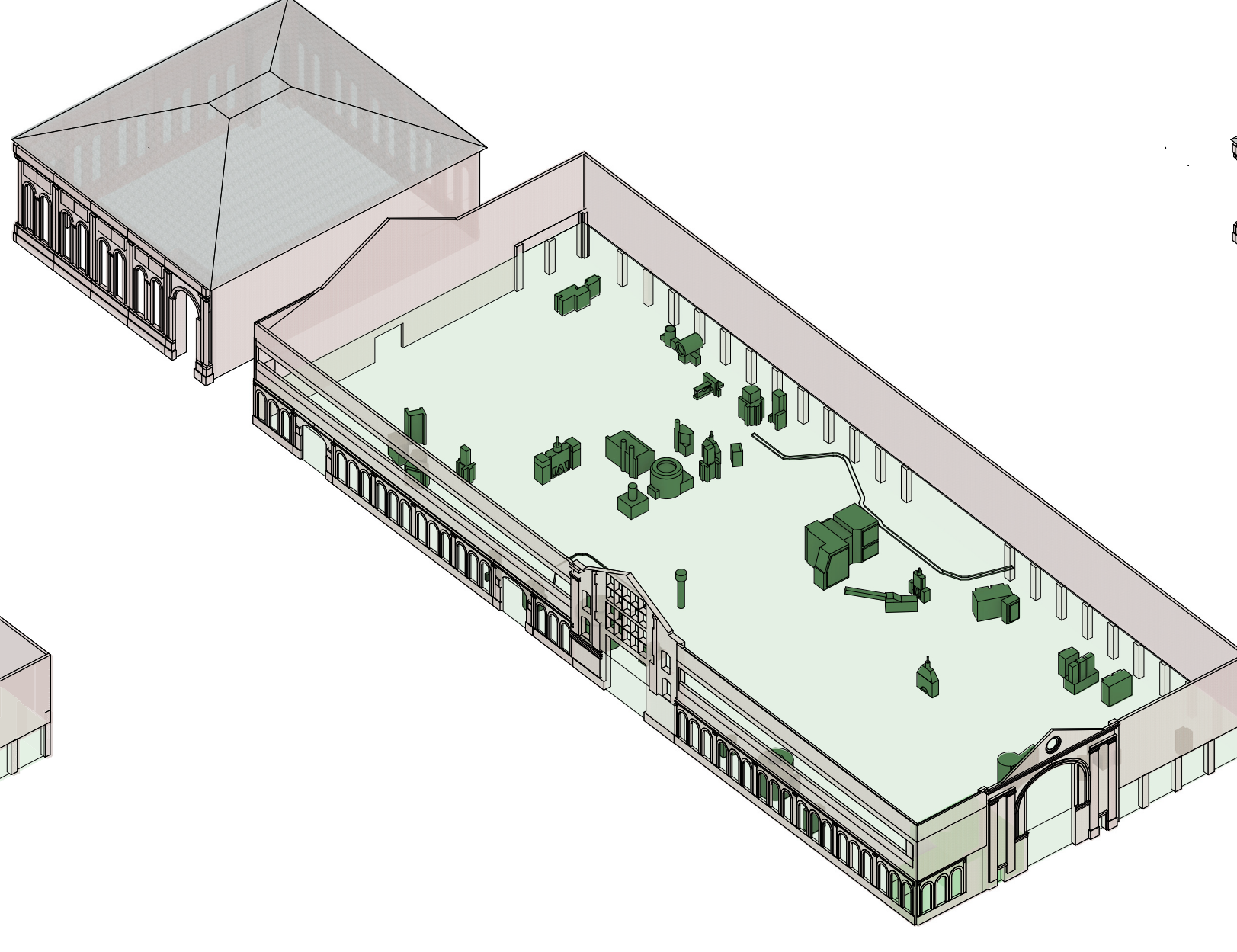
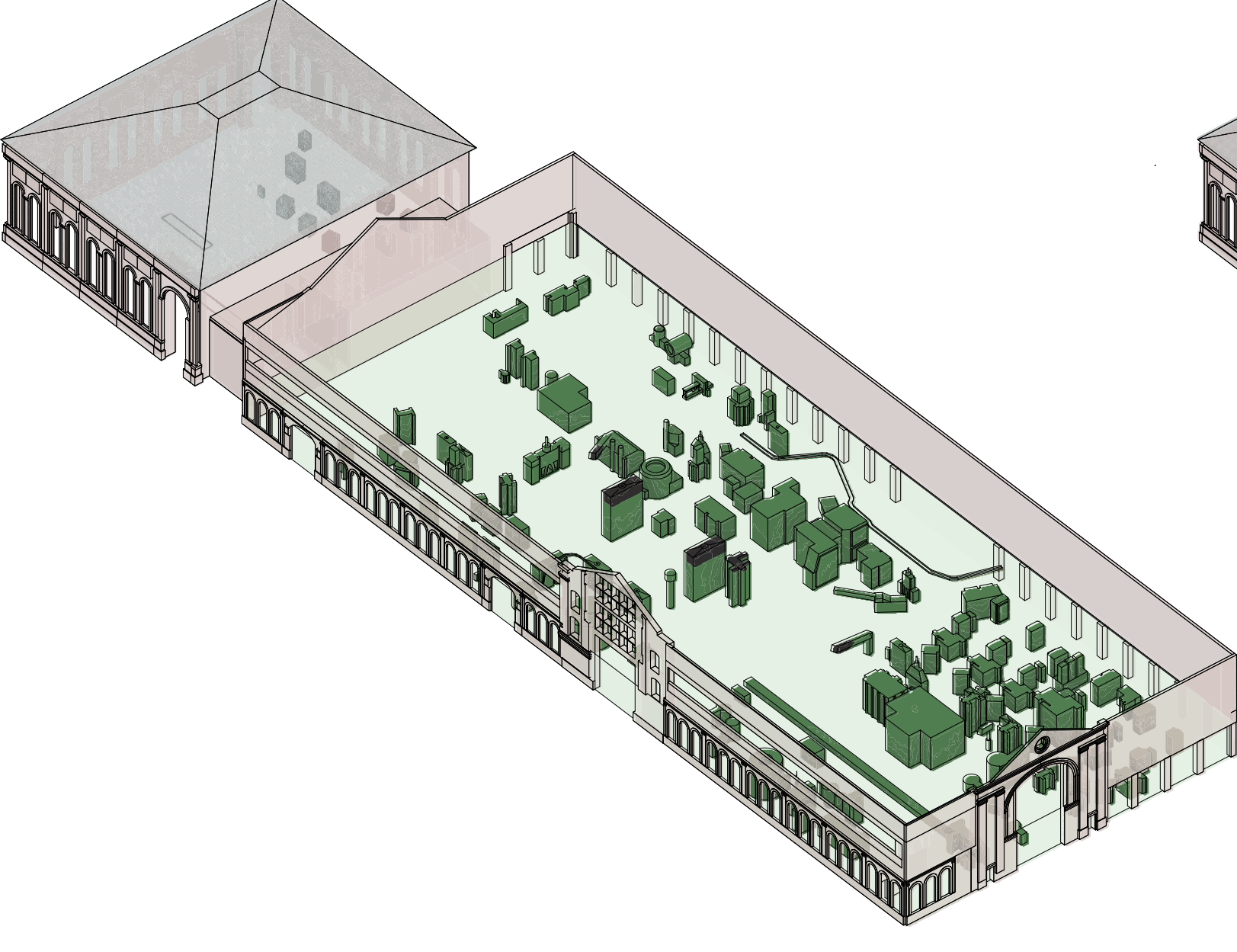

THE GARDEN

THE PARK

THE MARKET

COMPLETE

FACTORY FLOOR OPEN TO PUBLIC

SELECTIVE REMOVAL OF MACHINES

INTRODUCTION OF CORES

CONNECTOR BUILDING DEMOLISHED

NO DEFINED PROGRAM

WEEKLY MARKET ROTATION WITH MOBILE FOLLIES

LONG-TERM RENTAL NOW AVAILABLE

POWER HOUSE CONVERTED TO HOTEL LOBBY AND CAFE

4-6 MONTHS - SPRING AND EARLY SUMMER

6 MONTHS - SUMMER AND AUTUMN

1 YEAR

HOTEL IN FULL OPERATION



CHAIN FORGE MARKET

RELINKING CHARLESTOWN AND ITS
NAVY YARD

MACHINES

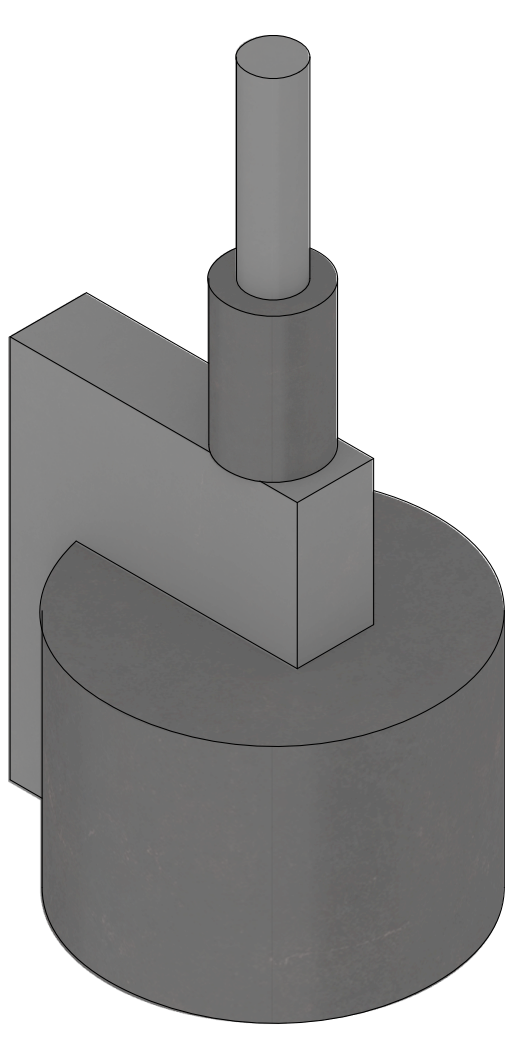

PLANTERS

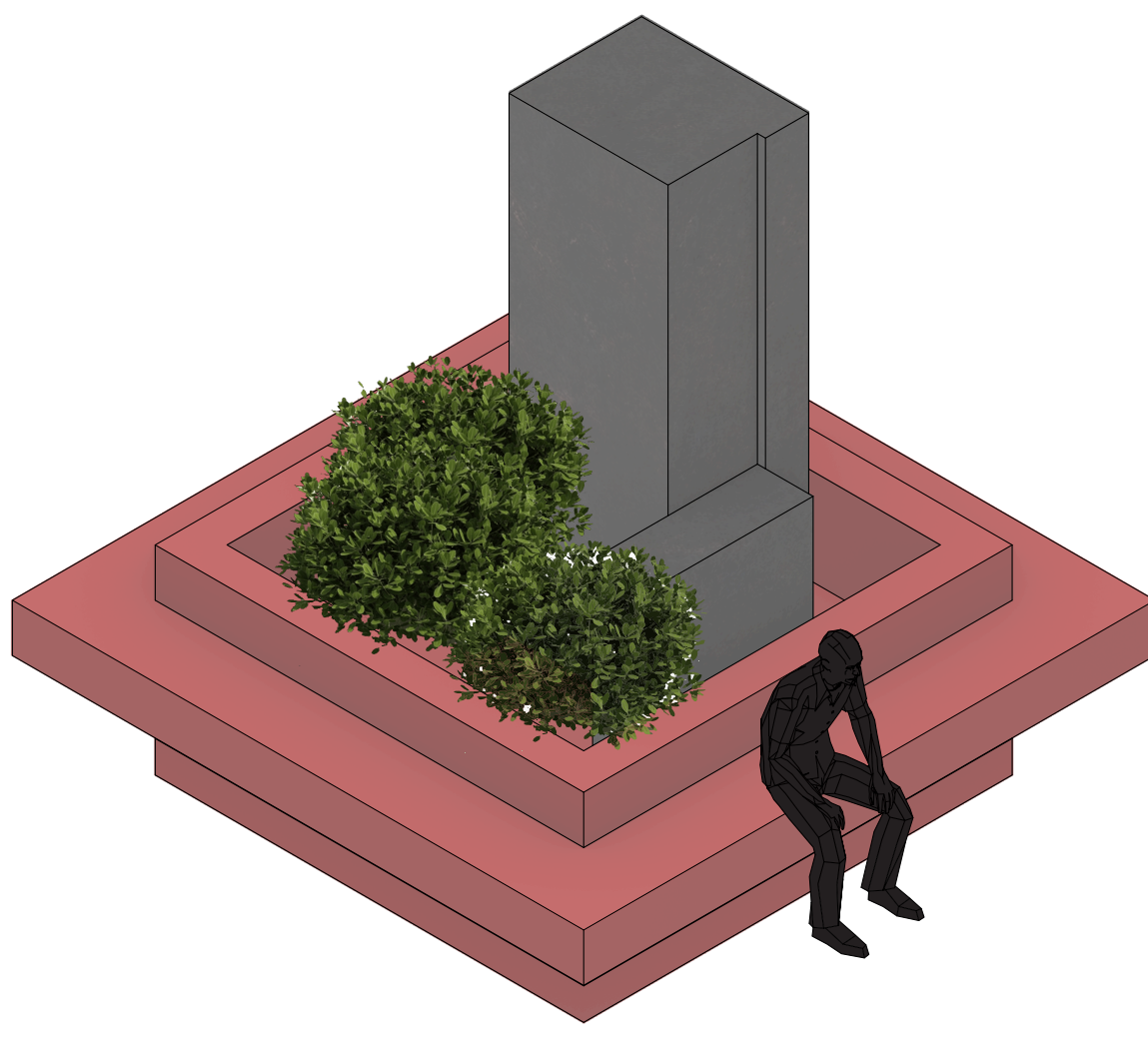
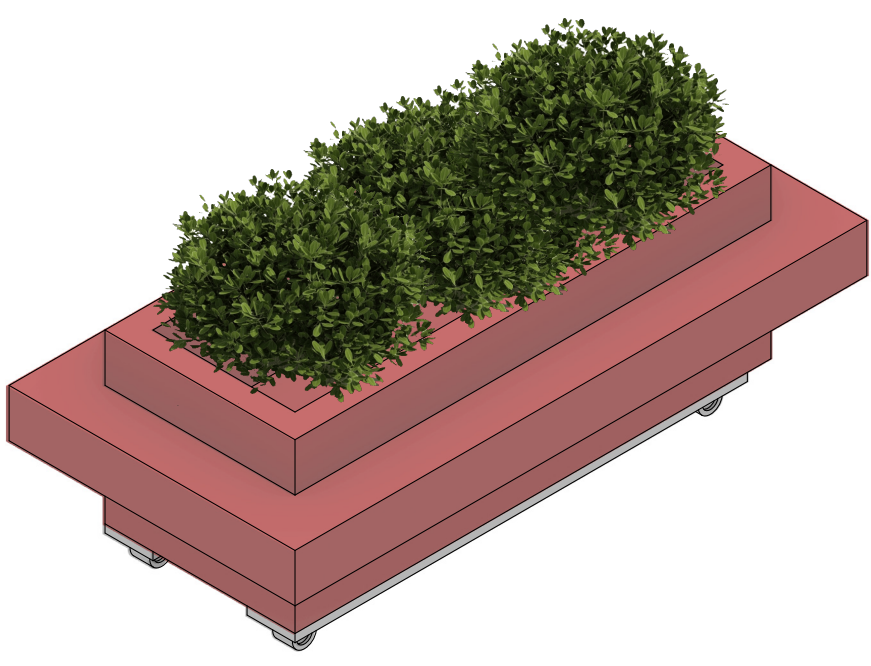
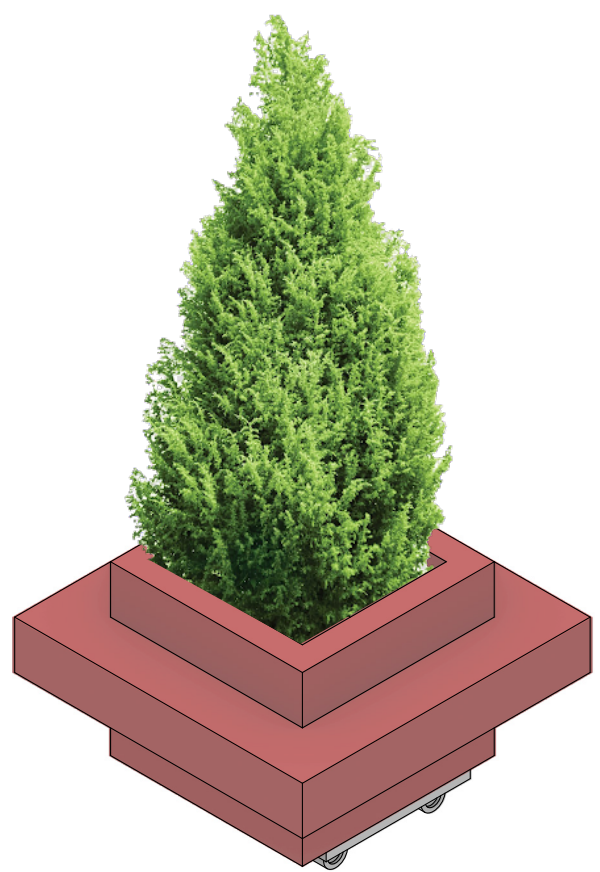

EVENT SPACE

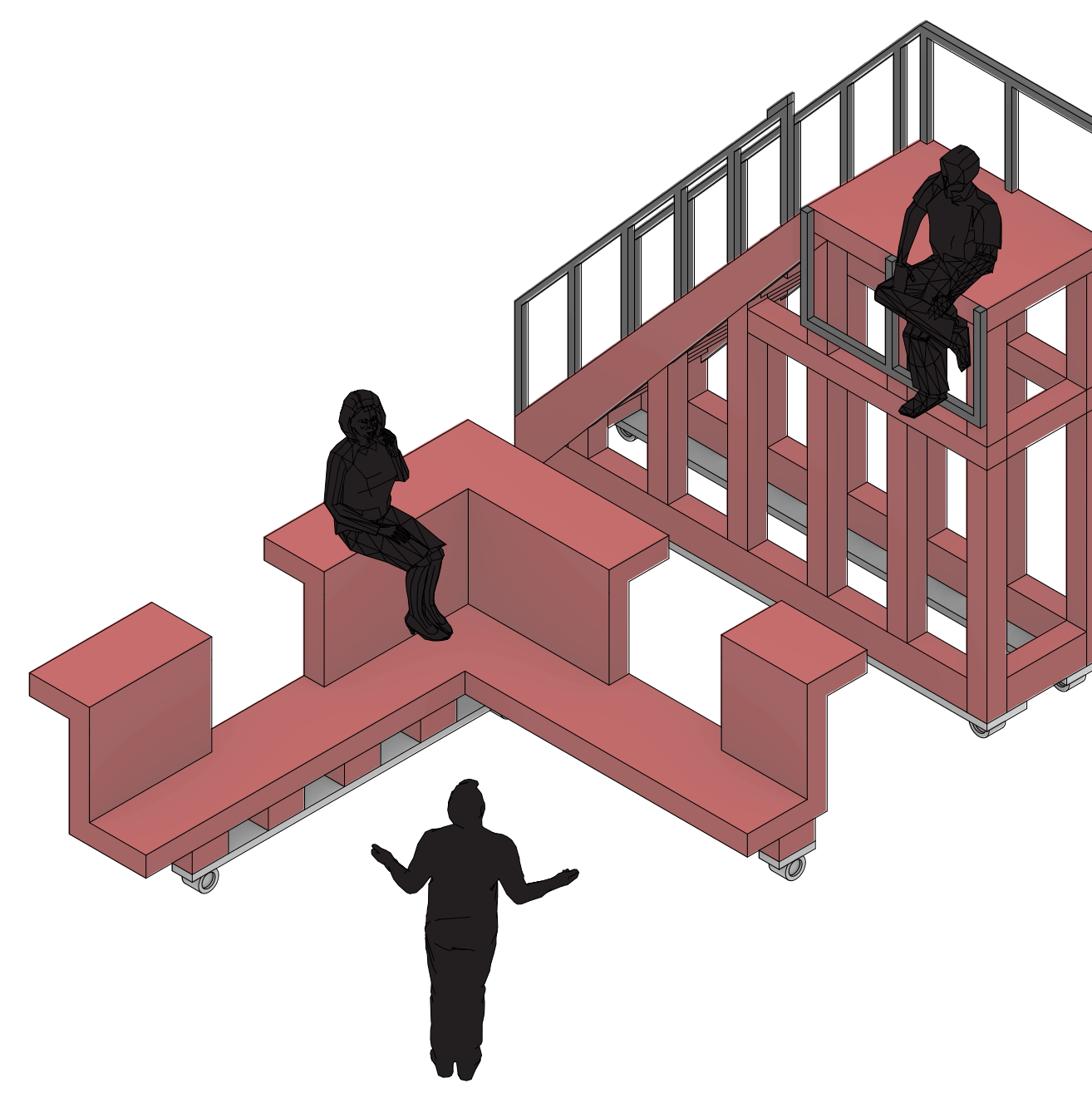

CANOPY STALLS
WEEKLY RENTAL

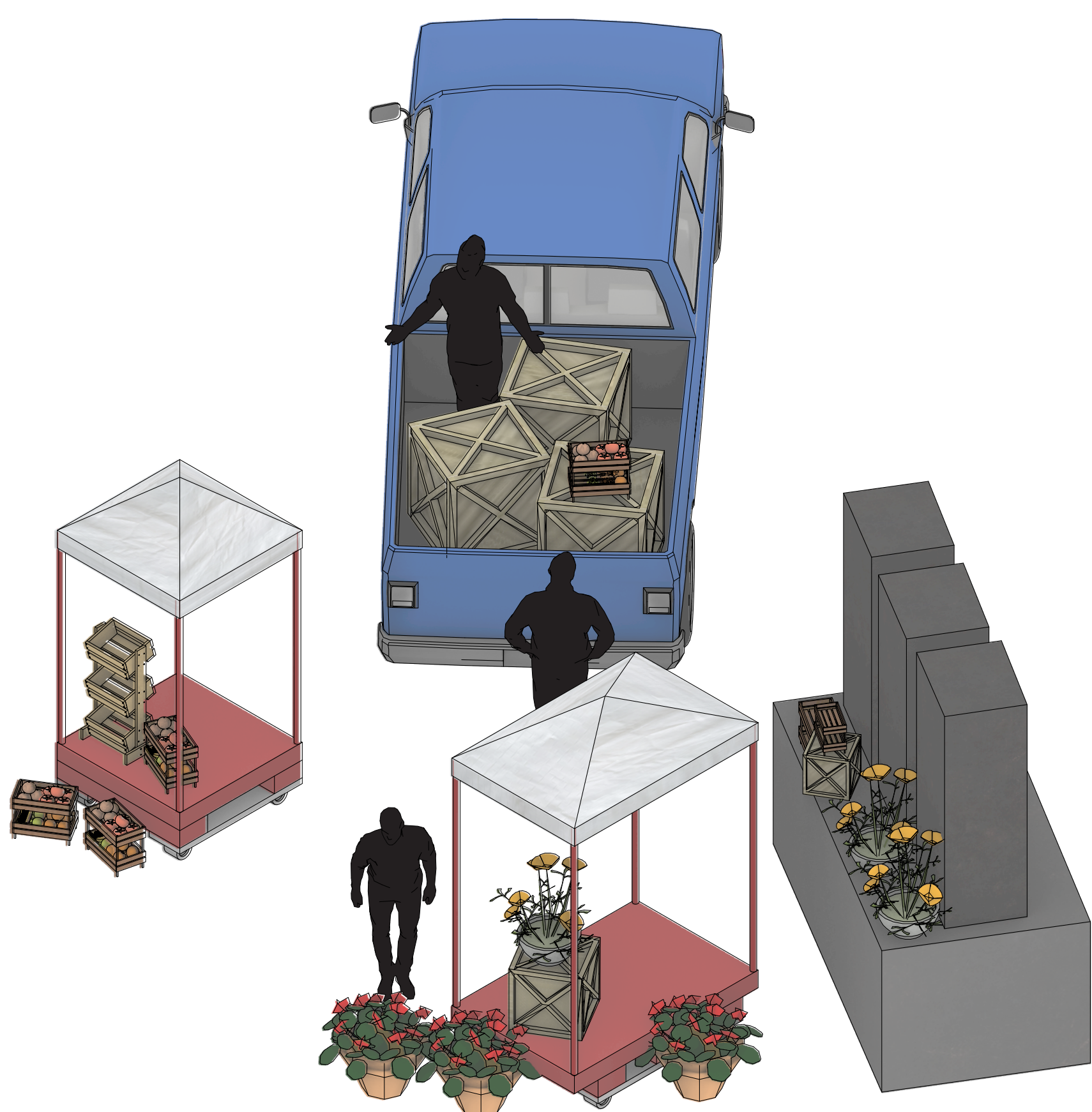

FOOD SERVICE STALLS
WEEKLY OR MONTHLY RENTAL

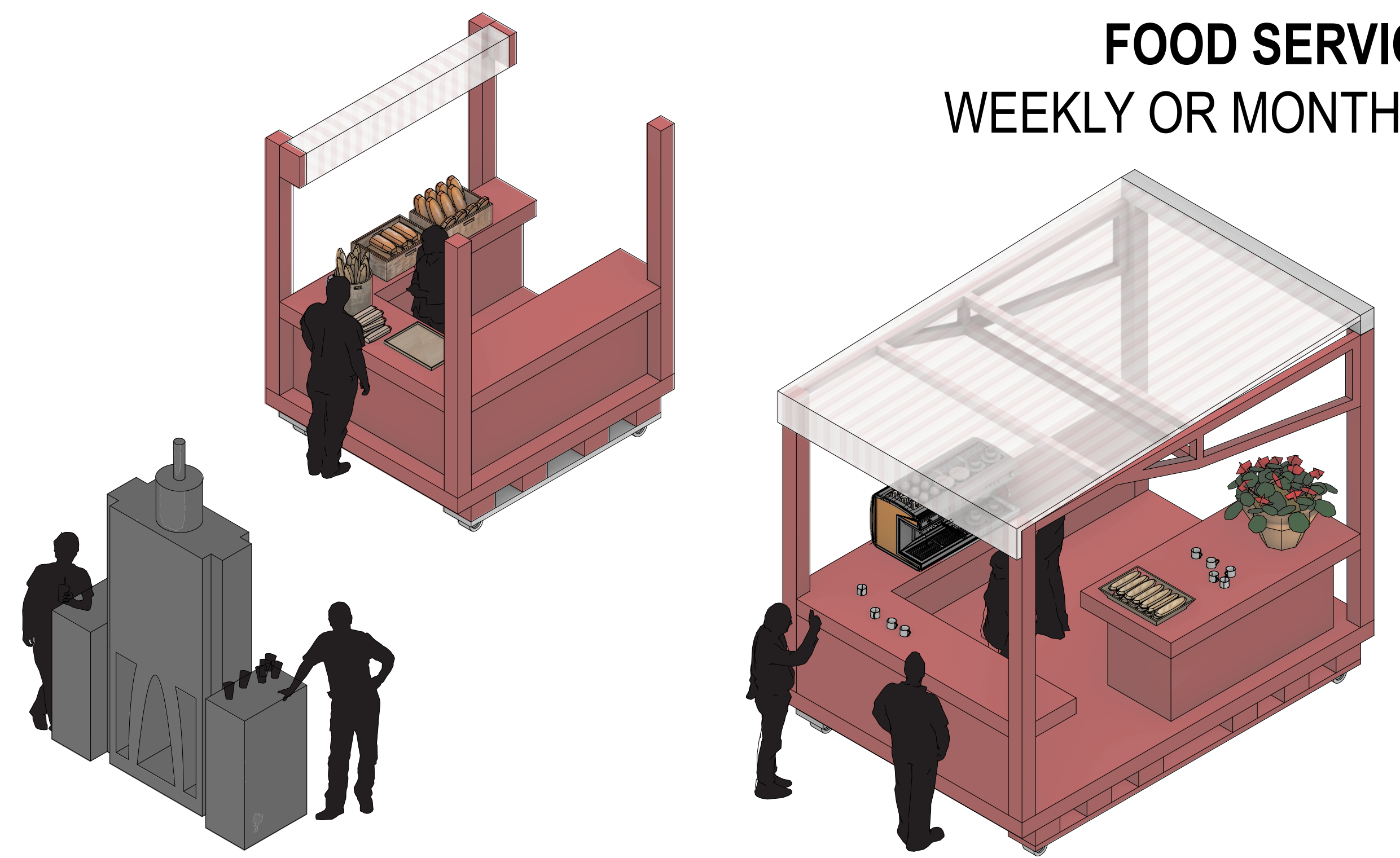

PERMANENT STRUCTURES
MONTHLY OR LONGER RENTAL

MOBILE STAIRCASES

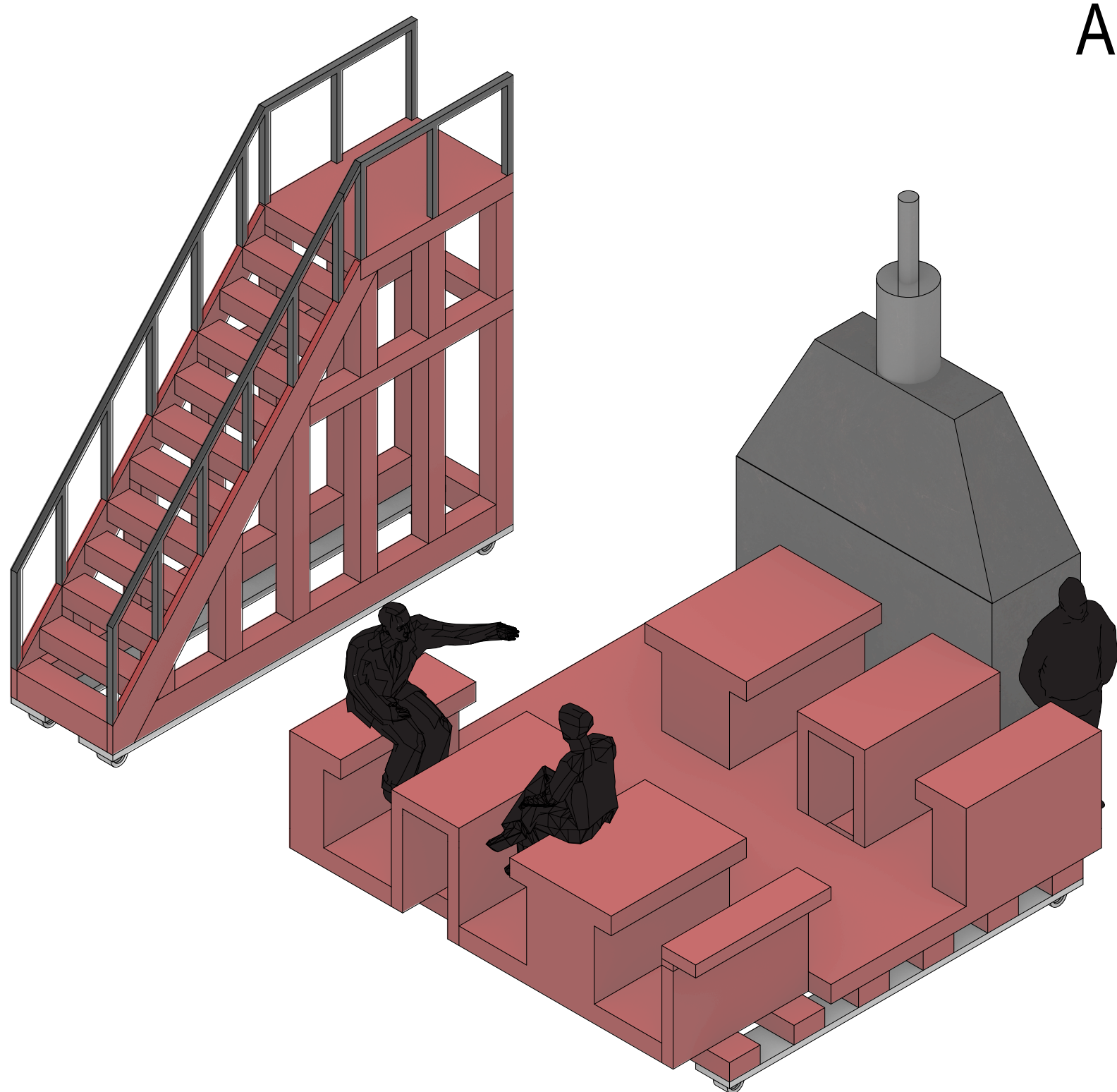

MOBILE SEATING PLATFORM
ADJUSTABLE DIVIDERS

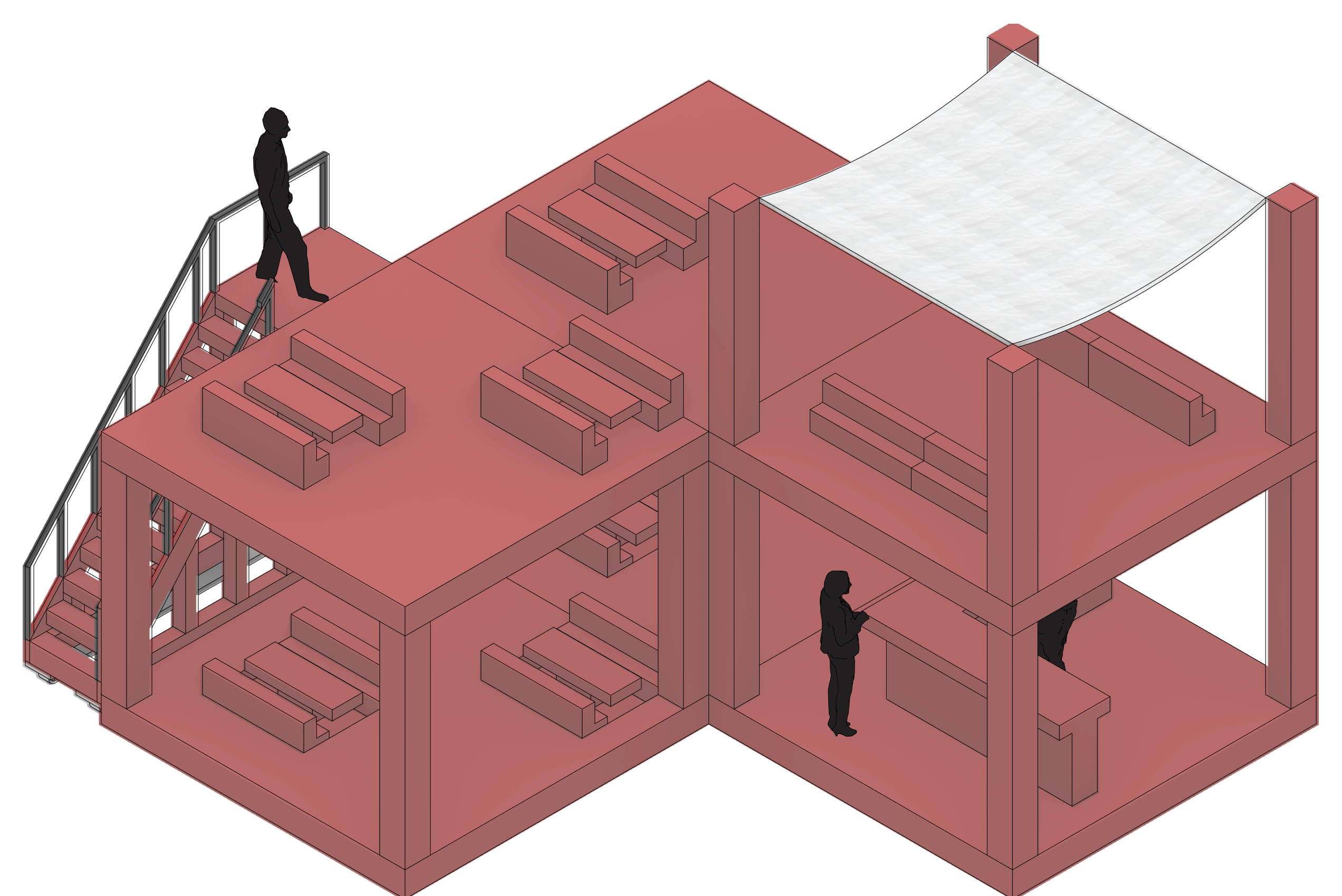



VARIATION

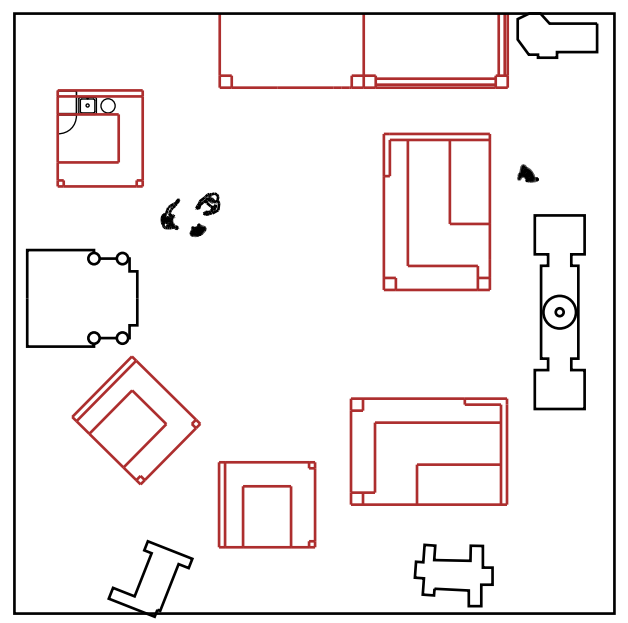

FOOD COURT

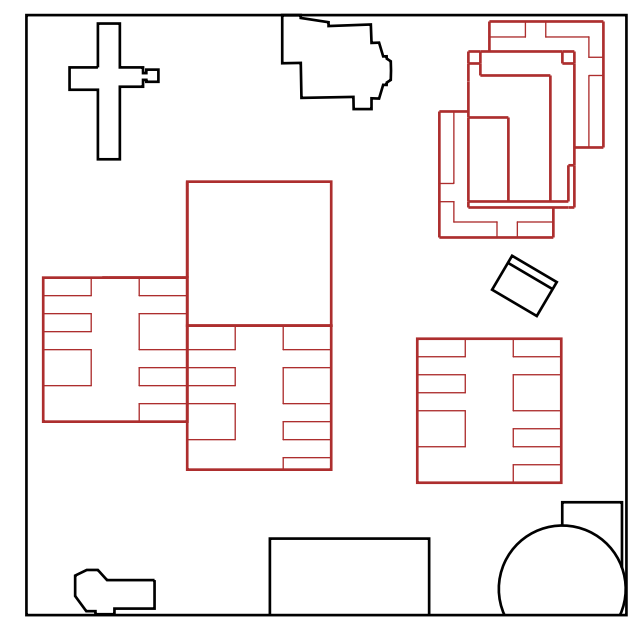

SEATING AREA

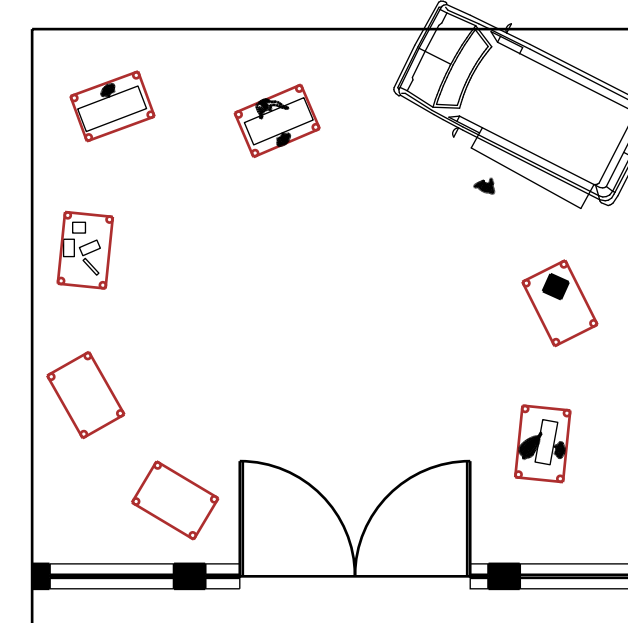

OUTDOOR MARKET

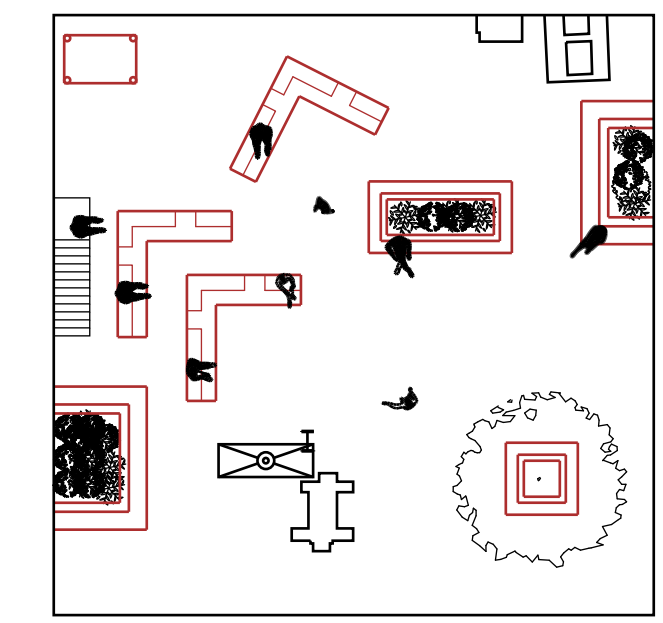

CONCERT VENUE

